

SKEMA®

Lumbertech
evolutionary wood



Lumbertech

evolutionary wood

Lumbertech oil 270	08
Lumbertech varnish 270	12
Lumbertech varnish 205	16
Lumbertech varnish S700	18
Lumbertech Modular	24
Accessori Accessories	30
Tabella Logistica Logistics Data Table	40

 **Sistema** **Patio** **Sonora** **Vertical** **Organica**

Lumbertech: legno ingegnerizzato

Lumbertech: engineered wood

Sostenibile, igienico, resistente, pratico, bello.

Sono i **5 punti** che fanno di Lumbertech il pavimento in **legno del futuro**.

- **SOSTENIBILE** perché utilizza $\frac{1}{8}$ di materia rispetto a un prefinito ed è legno certificato PEFC.
- **BELLO** grazie alle lavorazioni della superficie.
- **SICURO**, igienico e antibatterico, senza colle o aggrappanti, verniciato con vernice atossica, formaldeide free, che risponde alla norma europea EN 71; oppure oliato con oli e cere naturali.
- Un pavimento potenziato nella **RESISTENZA** ad urti e calpestio, ideale anche per gli ambienti pubblici.
- **PRATICO** perché antimpronta e con incastri protetti dall'acqua per **24 ore**.

Sustainable, hygienic, hard, practical, beautiful.

These are the **5 points** that make Lumbertech the **wooden floor of the future**.

- **SUSTAINABLE** because it uses $\frac{1}{8}$ less material than a pre-finished floor and is PEFC certified wood.
- **BEAUTIFUL** thanks to the surface processing.
- **SAFE**, hygienic and antibacterial, without glues or adhesives, varnished with non-toxic, formaldehyde-free varnish that meets the European EN 71 standard; or oiled with natural oils and waxes.
- **A HARD** floor, strengthened in its resistance to impact and treading, also ideal for public environments.
- **PRACTICAL** because it is anti-fingerprint and with joints protected from water for **24 hours**.

LumbertechOil
270
Rovere
Adamello

Sostenibilità Lumbertech

Lumbertech sustainability

Lumbertech è una superficie sostenibile, che oltre alle caratteristiche estetiche e tecniche, come la classe di reazione al fuoco Bfl-s1 e le versioni **Hydro24** (escluso il formato S700), vanta anche tante qualità che lo rendono un prodotto a basso impatto ambientale.

Naturalmente antibatterica e certificata **PEFC**, questa superficie non usa collanti o aggrappanti ed è realizzata con solo **1/8 di materia nobile** di legno rispetto ad un tradizionale prefinito stratificato.

La verniciatura utilizzata è senza formaldeide e atossica, mentre la versione oliata utilizza per la superficie una formulazione a base di oli e cere naturali.

Lumbertech contribuisce al risparmio energetico, infatti anche nel caso di posa su sistemi di riscaldamento a pavimento, Lumbertech vanta una **resistenza termica molto bassa**, così il pavimento non blocca il calore, anzi lo rilascia rapidamente fruttando al massimo il potere calorifico dell'impianto.

Lumbertech is a sustainable surface, which in addition to its aesthetic and technical features, such as the fire reaction class reaction to fire class Bfl-s1 and the **Hydro24** versions (excluding S700 size), it also boasts many qualities that make it an environmentally friendly product. Naturally antibacterial and **PEFC** certified, this surface uses no glues or adhesives and is made with only **1/8 of noble wood material** compared to a traditional layered pre-finished product. The paint used is formaldehyde-free and non-toxic, while the oiled version uses a formulation based on natural oils and waxes for the surface.

Lumbertech contributes to energy saving, in fact even when laid on underfloor heating systems, Lumbertech boasts a **very low thermal resistance**, so the floor does not block the heat, on the contrary it releases it quickly, maximising the heating power of the system.

USO DI LEGNO CERTIFICATO E RIDUZIONE DEL CONSUMO DI MATERIA NOBILE

USE OF CERTIFIED WOOD
AND REDUCTION OF NOBLE
MATERIAL CONSUMPTION



Classe d'aspetto / class of appearance

Le classi d'aspetto dei pavimenti in legno sono molto più di una questione di gusti. Sono la classificazione estetica della parte superiore della doga e sono definite dalla normativa europea UNI EN 13489:2018.

Le superfici delle collezioni **LUMBERTECH** seguono la dicitura della **Classe Libera: Nature / Ambiente / Rustic.**

NATURE

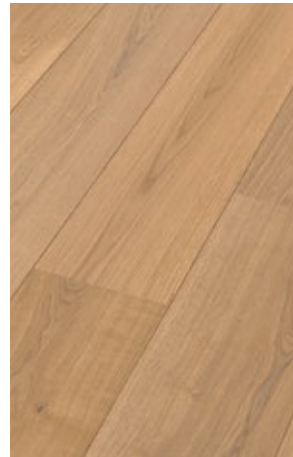

- Gioco equilibrato di colori e strutture
- Pochi nodi
- Quasi nessuna crepa
- I nodi e le piccolissime crepe sono riempiti con Wood Powder
- Balanced interplay of colours and textures
- Few knots
- Almost no cracks
- Knots and very small cracks are filled with Wood Powder

AMBIENTE

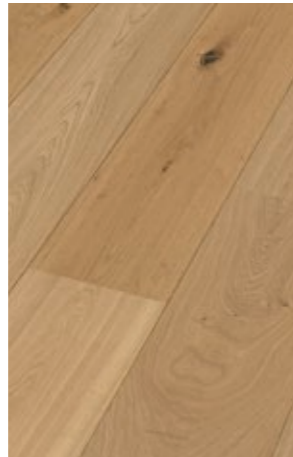

- Variazioni di colore e differenze strutturali tra le tavole
- Crepe, nodi sani e caratteristici
- Leggere Spaccature
- Nodi e crepe sono riempiti con Wood Powder
- Colour variations and structural differences between boards
- Crepe, sound and characteristic knots
- Slight Cracks
- Knots and cracks are filled with Wood Powder

RUSTIC

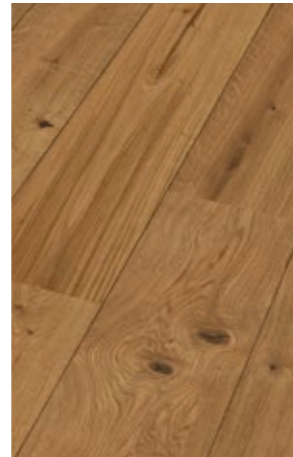

- Le variazioni di colore e le differenze strutturali tra le tavole
- Nodi e crepe
- Fessure sane, non limitate per dimensione o quantità
- Elementi isolati di alburno
- Nodi e crepe sono riempiti con Wood Powder
- Colour variations and structural differences between boards
- Knots and cracks
- Healthy cracks, not limited in size or quantity
- Isolated sapwood elements
- Knots and cracks are filled with Wood Powder

The appearance classes of wooden floors are much more than a matter of taste. They are the aesthetic classification of the top of the plank and are defined by the European standard UNI EN 13489:2018.

The surfaces of the **LUMBERTECH** collections follow the **Free Class** classification: **Nature / Ambiente / Rustic.**

Finitura finale / Final Finishing

Oil

La finitura ad **olio** utilizza una formulazione di oli e cere naturali nel **rispetto della filosofia ecosostenibile** di tutta la linea Lumbertech e forma una superficie protettiva della doga che mantiene l'aspetto naturale del legno. L'oliatura lascia respirare il legno agevolando la naturale regolazione dell'umidità.

The **oil** finish uses a formulation of natural oils and waxes in keeping with the **eco-sustainable philosophy** of the entire Lumbertech line and forms a protective surface of the plank that maintains the natural appearance of the wood. The oiling allows the wood to breathe, facilitating natural moisture regulation.

Varnish

La **verniciatura** con cui è rifinita la superficie è a **zero gloss**, per un effetto opaco che lascia inalterato l'aspetto autentico del legno e lo protegge dalle aggressioni chimiche, senza formaldeide e atossica. La superficie così richiede **poca manutenzione** e ne guadagna anche in resistenza alla macchie e ai prodotti chimici.

The **varnish** with which the surface is finished is **zero-gloss**, for a matt effect that leaves the authentic appearance of the wood intact and protects it from chemical aggression, formaldehyde-free and non-toxic. The surface thus requires **little maintenance** and also gains in stain and chemical resistance.



Legenda Caratteristiche / Features Legend

- 1 Nucleo / Core
- 2 Alburno / Sapwood
- 3 Differenze strutturali / Structural differences
- 4 Nodo con polvere di legno / Knot with wood powder
- 5 Crepa / Crack
- 6 Variazione di colore / Colour variations
- 7 Nod sani / Healthy knots

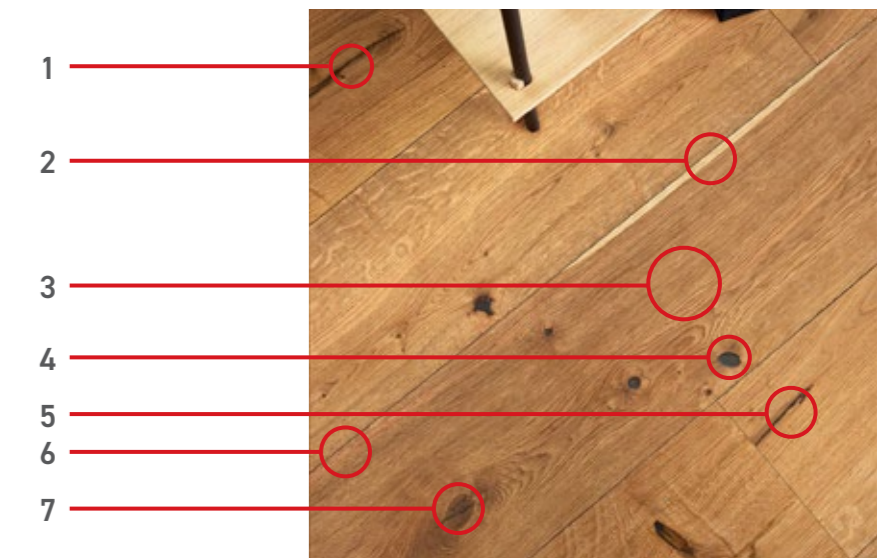



line **Lumbertech** Oil 270

Lumbertech Oil, è il pavimento in legno potenziato nella resistenza al calpestio e agli urti, con finitura superficiale oliata, realizzata con 1/8 di legno nobile rispetto al prefinito tradizionale. La spazzolatura profonda della superficie è rifinita con una formulazione a base di oli e cere naturali che permettono di vivere ogni giorno la bellezza del legno e mettono in risalto le sue venature e le sue differenti tonalità. La versione oil è dotata di tecnologia **Hydro 24** che protegge le giunzioni dalla penetrazione dell'acqua per 24 ore. Naturalmente antibatterica, questa superficie è realizzata nel rispetto dell'ambiente e della salute, un prodotto certificato **PEFC**, che non usa collanti o aggrappanti, con classe di reazione al fuoco **Bfl-s1**.

Lumbertech Oil is a wooden floor with an oiled surface finishing that is enhanced in terms of resistance to footsteps and impact. The deep brushing of the surface is finished with a composition based on natural oils and waxes that allow you to live the beauty of wood every day and highlight its veins and different shades. The oil version is equipped with **Hydro 24** technology that protects the joints from water penetration for 24 hours. Naturally anti-bacterial, this surface is made with respect for the environment and health, a **PEFC** certified product, which does not use glues or adhesives, with fire reaction class **Bfl-s1**.



INFO LUMBERTECH
OIL 270

Lumbertech Oil 270 Rovere Yellowstone

Lumbertech Oil 270

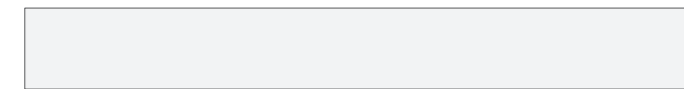

2200 x 270 x 11 mm

Info:

Incastro joint		TLS PLUS
Bisello bevel		
Reazione al Fuoco * Fire reaction *		Bfl-s1
Riscaldamento a pavimento Suitable for radiant heating		Adatto Suitable T ≤ 27°C
Accessori abbinabili Matching accessories		

Lumbertech, esprime il meglio di sé quale pavimento flottante abbinato al materassino **Superior RBR** ma grazie alla tecnologia di costruzione Wood Powder può essere posato anche in aderenza totale con colla. È fondamentale tener conto delle indicazioni del protocollo di incollaggio Skema. Vedi QRcode.

Lumbertech, expresses itself at its best as a floating floor combined with **Superior RBR** matting, but thanks to the Wood Powder construction technology it can also be laid in full adhesion with glue. It is essential to take into account the information in the Skema bonding protocol. See QRcode.



* Classificazione valida con l'utilizzo dei sottopavimenti e/o modalità indicate da Skema S.p.A. (per dettagli vedi scheda tecnica del prodotto e/o istruzioni per l'installazione).

* Classification valid with the use of underlayer and/or modality specified by Skema S.p.A. (please see product technical data sheet and/or installation instructions for details).

Certificazioni / Certifications:



Accessori / Accessories:

Sottopavimenti Underlayer	Superior RBR - DB
Profilo Profile	Kit Dilatazione + Terminale + Profilo Scala Expansion Kit + Terminal Kit + Stair Profile
Battiscopa Skirting Board	Star - Look - Time

Confezionamento / Packaging:

Rif. formato/Size	Pz/Pcs	m ²	Confezione/Box	m ²
2200x270	4	2,376	30	71,28

Lumbertech Oil 270

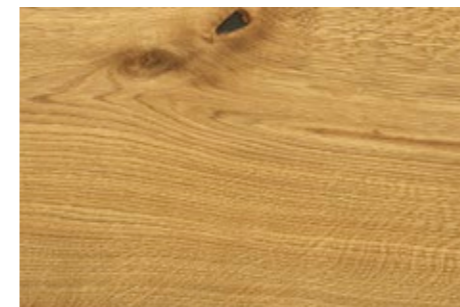

1430 Rovere Adamello
Rustic - **CL**

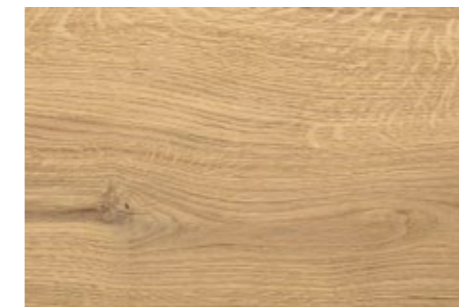

1431 Rovere Gran Paradiso
Rustic - **CL**



1432 Rovere Yellowstone
Nature - **CL**

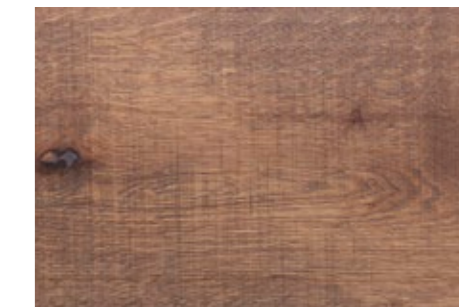

1434 Rovere Circeo
Rustic - Trame - **CL**



1435 Rovere Gargano
Nature - Trame - **CL**



1436 Noce Reale
Comfort - **CL**



1437 Rovere Arenal
Nature - Trame - **CL**

NOTA: La finitura **Noce Reale**, è leggermente spazzolata, può presentare maggiore sensibilità ai graffi. /
NOTE: **Noce Reale** finish, with its only slightly brushed finish, may be more susceptible to scratches.

CL: vedi Classe Libera a pag. 38 / see Open Class on page. 38



Book Finiture
Finishing Book



line **Lumbertech** Varnish 270 e 205

La linea di pavimenti in legno ingegnerizzato **Lumbertech**, nella versione **Varnish**, punta ad offrire un'esperienza sensoriale dove viene esaltata la naturalità del legno. La verniciatura con cui è rifinita la superficie è a zero gloss, per un effetto opaco che lascia inalterato l'aspetto autentico del legno e lo protegge dalle aggressioni chimiche, senza formaldeide e atossica. Una vernice durevole, sicura anche per i bambini, di facile manutenzione ed eco friendly, nel rispetto della filosofia della linea **Lumbertech**, realizzata con 1/8 di legno nobile rispetto ad un prefinito tradizionale. Lumbertech Varnish è **Hydro24, antibatterico, certificato PEFC**. Disponibile in due versioni: nel formato **2200x270x11 mm** e nel formato **2200x205x11 mm**.

The **Lumbertech** engineered wood flooring range, in its Varnish version, aims to offer a sensory experience where the naturalness of wood is enhanced. The varnish with which the surface is finished is zero-gloss, for a matt effect that leaves the authentic look of the wood intact and protects it from chemical aggression, formaldehyde-free and non-toxic. A durable varnish, safe even for children, easy to maintain and eco-friendly, in keeping with the Lumbertech line philosophy, made with 1/8 of noble wood compared to a traditional pre-finished product. Lumbertech Varnish is **Hydro24, antibacterial, PEFC certified**. Available in two versions: in the **2200x270x11 mm** format and in the **2200x205x11 mm** format.



INFO LUMBERTECH
VARNISH 270



INFO LUMBERTECH
VARNISH 205

Lumbertech

Varnish 270

Rovere Brenta

Lumbertech Varnish 270

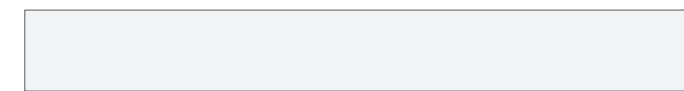

2200 x 270 x 11 mm

Info:

Incastro joint		TLS PLUS
Bisello bevel		
Reazione al Fuoco * Fire reaction *		Bfl-s1
Riscaldamento a pavimento Suitable for radiant heating		Adatto Suitable T ≤ 27°C
Accessori abbinabili Matching accessories		

Lumbertech, esprime il meglio di sé quale pavimento flottante abbinato al materassino **Superior RBR** ma grazie alla tecnologia di costruzione Wood Powder può essere posato anche in aderenza totale con colla. È fondamentale tener conto delle indicazioni del protocollo di incollaggio Skema. Vedi QRcode.

Lumbertech, expresses itself at its best as a floating floor combined with **Superior RBR** matting, but thanks to the Wood Powder construction technology it can also be laid in full adhesion with glue. It is essential to take into account the information in the Skema bonding protocol. See QRcode.



* Classificazione valida con l'utilizzo dei sottopavimenti e/o modalità indicate da Skema S.p.A. (per dettagli vedi scheda tecnica del prodotto e/o istruzioni per l'installazione).

* Classification valid with the use of underlayer and/or modality specified by Skema S.p.A. (please see product technical data sheet and/or installation instructions for details).

Certificazioni / Certifications:



Accessori / Accessories:

Sottopavimenti Underlayer	Superior RBR - DB
Profilo Profile	Kit Dilatazione + Terminale + Profilo Scala Expansion Kit + Terminal Kit + Stair Profile
Battiscopa Skirting Board	Star - Look - Time

Confezionamento / Packaging:

Rif. formato/Size	Pz/Pcs 	m ²	Confezione/Box 	m ²
2200x270	4	2,376	30	71,28

Lumbertech Varnish 270

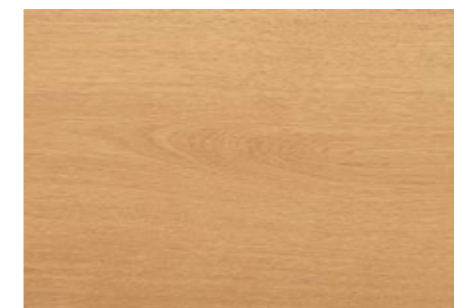

1438 Rovere Arches
Ambiente - **CL**

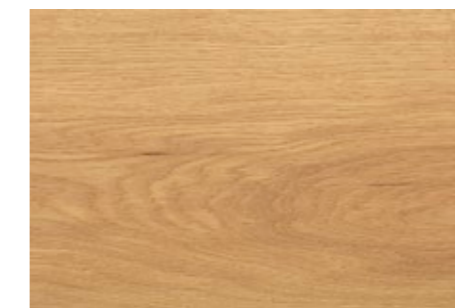

1439 Rovere Caspio
Nature - **CL**

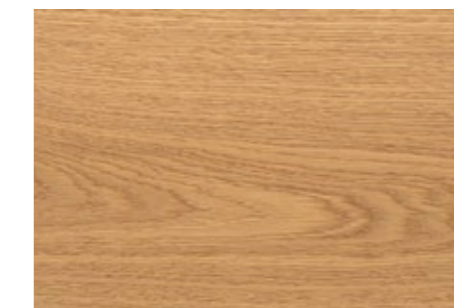

1440 Rovere Ontario
Ambiente - **CL**



1441 Rovere Sila
Nature - **CL**



1442 Rovere Pollino
Nature - **CL**

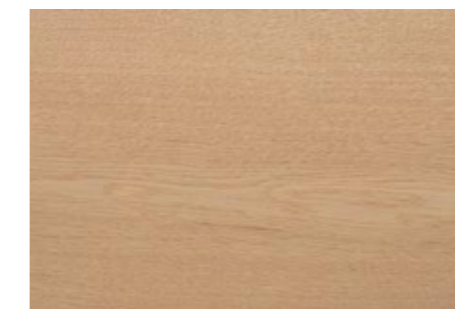

1443 Rovere Conero
Nature - **CL**

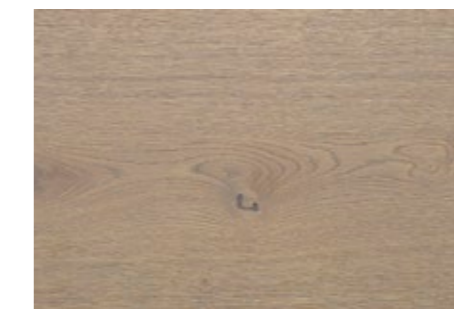

1444 Rovere Valsesia
Ambiente - **CL**

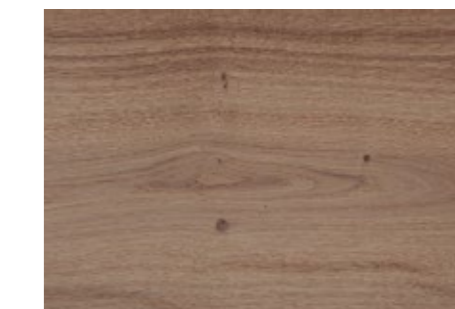

1451 Rovere Brenta
Rustic - **CL**

CL: vedi Classe Libera a pag. 38 / see Open Class on page. 38



Lumbertech Varnish 205



2200 x 205 x 11 mm

Info:

Incastro joint		TLS PLUS
Bisello bevel		
Reazione al Fuoco * Fire reaction *		Bfl-s1
Riscaldamento a pavimento Suitable for radiant heating		Adatto Suitable T ≤ 27°C
Accessori abbinabili Matching accessories		

Lumbertech, esprime il meglio di sé quale pavimento flottante abbinato al materassino **Superior RBR** ma grazie alla tecnologia di costruzione Wood Powder può essere posato anche in aderenza totale con colla. È fondamentale tener conto delle indicazioni del protocollo di incollaggio Skema. Vedi QRcode.

Lumbertech, expresses itself at its best as a floating floor combined with **Superior RBR** matting, but thanks to the Wood Powder construction technology it can also be laid in full adhesion with glue. It is essential to take into account the information in the Skema bonding protocol. See QRcode.



* Classificazione valida con l'utilizzo dei sottopavimenti e/o modalità indicate da Skema S.p.A. (per dettagli vedi scheda tecnica del prodotto e/o istruzioni per l'installazione).
* Classification valid with the use of underlayer and/or modality specified by Skema S.p.A. (please see product technical data sheet and/or installation instructions for details).



Certificazioni / Certifications:



Accessori / Accessories:

Sottopavimenti Underlayer	Superior RBR - DB
Profilo Profile	Kit Dilatazione + Terminale + Profilo Scala Expansion Kit + Terminal Kit + Stair Profile
Battiscopa Skirting Board	Star - Look - Time

Confezionamento / Packaging:

Rif. formato/Size	Pz/Pcs 	m ²	Confezione/Box 	m ²
2200x205	4	1,80	40	72,16

Lumbertech Varnish 205

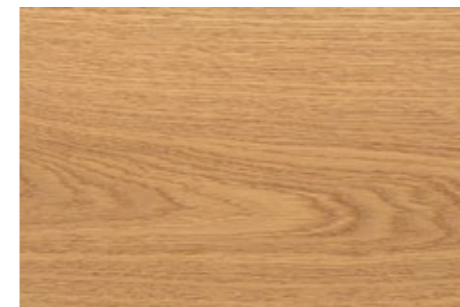

1452 Rovere Ontario 205
Ambiente - **CL**

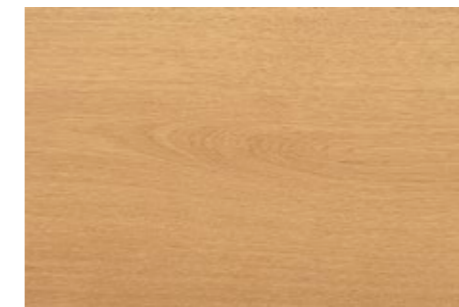

1453 Rovere Arches 205
Ambiente - **CL**

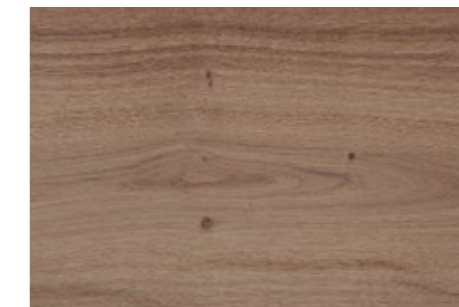

1455 Rovere Brenta 205
Ambiente - **CL**

CL: vedi Classe Libera a pag. 38 / see Open Class on page. 38



Book Finiture
Finishing Book



line **Lumbertech** Varnish S700

L'eleganza della spina si fa tecnologica e resistente con **Lumbertech**. La versione **S700** propone il pavimento in legno potenziato con il Wood Powder nel formato Spina, il pattern è il più classico, quello della spina italiana con teste a 90°. Ritmo e raffinatezza si uniscono così alle tante qualità di Lumbertech che permette di inserire il pavimento in legno, con posa a spina di pesce, in ambienti ad alto traffico, come hotel, ristoranti e spazi pubblici. **S700** si connota anche per l'incastro PLS, che garantisce la tenuta della chiusura con un effetto meccanico a forcilla lungo tutta la lunghezza dell'incastro e velocizza i tempi di posa. **Lumbertech S700** è proposto nel formato **700x140x11 mm** e con finitura superficiale verniciata.

The elegance of the herringbone becomes technological and resistant with **Lumbertech**. The **S700** version presents the wooden floor enhanced with Wood Powder in the Herringbone pattern; the pattern is the most classic one, the Italian Herringbone with 90° cut on the short side. Rhythm and elegance are combined with the many qualities of Lumbertech, which makes it possible to insert the wooden floor, with herringbone application, in high traffic environments, such as hotels, restaurants and public spaces. **S700** is also characterised by the PLS joint, which guarantees the strength of the closure with a mechanical fork effect along the entire length of the joint and accelerates installation times. **Lumbertech S700** is available in the **700x140x11 mm** size and with a varnished surface finish.

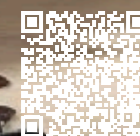

INFO LUMBERTECH
VARNISH S700

Lumbertech
Varnish S700
Rovere
Pollino

Lumbertech Varnish S700

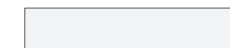

700 x 140 x 11 mm

Info:

Incastro joint		PLS
Bisello bevel		
Reazione al Fuoco * Fire reaction *		Bfl-s1
Riscaldamento a pavimento Suitable for radiant heating		Adatto Suitable T ≤ 27°C
Accessori abbinabili Matching accessories		

Lumbertech, esprime il meglio di sé quale pavimento flottante abbinato al materassino **Superior RBR** ma grazie alla tecnologia di costruzione Wood Powder può essere posato anche in aderenza totale con colla. È fondamentale tener conto delle indicazioni del protocollo di incollaggio Skema. Vedi QRcode.

Lumbertech, expresses itself at its best as a floating floor combined with **Superior RBR** matting, but thanks to the Wood Powder construction technology it can also be laid in full adhesion with glue. It is essential to take into account the information in the Skema bonding protocol. See QRcode.



* Classificazione valida con l'utilizzo dei sottopavimenti e/o modalità indicate da Skema S.p.A. (per dettagli vedi scheda tecnica del prodotto e/o istruzioni per l'installazione).

* Classification valid with the use of underlayer and/or modality specified by Skema S.p.A. (please see product technical data sheet and/or installation instructions for details).



Certificazioni / Certifications:



Accessori / Accessories:

Sottopavimenti Underlayer	Superior RBR - DB
Profilo Profile	Kit Dilatazione + Terminale + Profilo Scala Expansion Kit + Terminal Kit + Stair Profile
Battiscopa Skirting Board	Star - Look - Time

Confezionamento / Packaging:

Rif. formato/Size	Pz/Pcs 	m ²	Confezione/Box 	m ²
700x140	10	0,980	56	54,88

Lumbertech Varnish S700

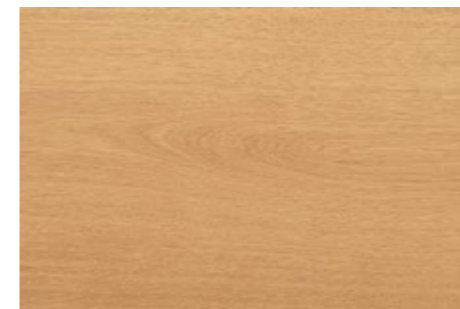

1445 Rovere Arches Spina
Ambiente - **CL**

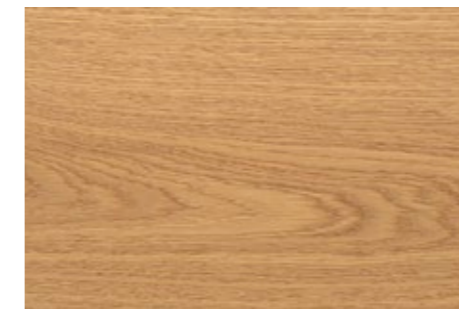

1446 Rovere Ontario Spina
Ambiente - **CL**



1447 Rovere Pollino Spina
Ambiente - **CL**

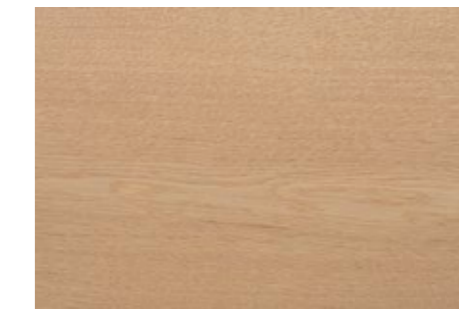

1448 Rovere Conero Spina
Ambiente - **CL**

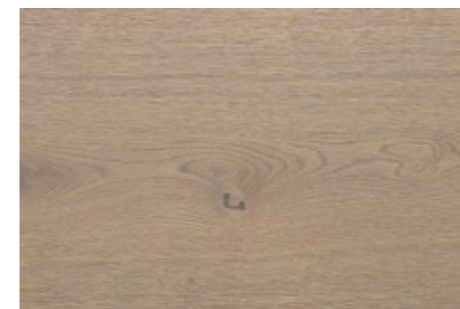

1449 Rovere Valsesia Spina
Ambiente - **CL**



1450 Noce Classico Spina
Ambiente - **CL**

CL: vedi Classe Libera a pag. 38 / see Open Class on page. 38



Book Finiture
Finishing Book

Lumbertech negli spazi commerciali

Lumbertech in Commercial Spaces

Le proprietà e caratteristiche del pavimento e rivestimento Lumbertech ne fanno un alleato strategico per pose in spazi pubblici e/o commerciali.

Hotel, negozi, uffici, esposizioni temporanee o Show Room possono così riconquistare l'impiego di un **legno tecnologico** qual è Lumbertech.

The features and characteristics of Lumbertech floor and wall coverings make them a strategic ally for laying in public and/or commercial spaces.

Hotels, shops, offices, temporary exhibitions or showrooms can thus regain the use of a **technological wood** such as Lumbertech.



From Flooring to Furniture



line Lumbertech Modular

Lumbertech Modular è l'innovativo progetto sistemico che, a partire dalla dogia Lumbertech tagliata in più misure, rivoluziona la falegnameria moderna realizzata in opera, rivitalizzando in chiave contemporanea l'arte dell'ebanisteria. La dogia Lumbertech, tagliata, può così diventare unità modulare e dar vita a una libreria, una parete attrezzata con cablaggi a scomparsa, un'intera camera d'albergo, un bagno, una panchina, dei tavoli e dei banconi d'appoggio. Una soluzione per il mondo contract e non solo che porta i valori Lumbertech, come la resistenza, la naturalezza del legno e la tutela della materia prima, nel mondo dell'arredo d'interni.

Lumbertech Modular is the innovative systemic project that, starting from the Lumbertech plank divided into several sizes, changes the modern carpentry realized on site, revitalizing the art of cabinet-making in a contemporary way. The Lumbertech plank can thus become a modular unit and give life to a bookcase, a wall equipped with hidden cabling, an entire hotel room, a bathroom, a bench, tables and countertops. A solution for the contract world and not only, which brings Lumbertech values, such as the resistance, the naturalness of wood and the protection of raw materials, into the world of interior design.



LUMBERTECH Modular

La **materia** di partenza è composta dagli elementi delle tavole standard di **Lumbertech**, offerta nell'intera gamma delle finiture, per la realizzazione degli elementi delle _Librerie, _Tavoli ecc...

The starting **material** consists of the elements of the standard planks, offered in the entire range, for the construction of _ Bookcases and _Tables.



Gli elementi / Elements

Skema fornisce gli elementi realizzati in Lumbertech Modular in versione monofacciale per arredi addossati a parete oppure in versione bifacciale, per arredi a giorno. Questi elementi vengono forniti in lunghezze fisse oppure, a richiesta, su misura.

Skema supplies the elements made of Lumbertech Modular in a single-sided version for wall-mounted furnishings or in a double-sided version for day furnishings. These elements are supplied in fixed lengths or customised on request.

LUMBERTECH MODULAR VERTICAL



H_2200 mm
L_350 mm monofacciale
L_450 mm bifacciale
P_87 mm

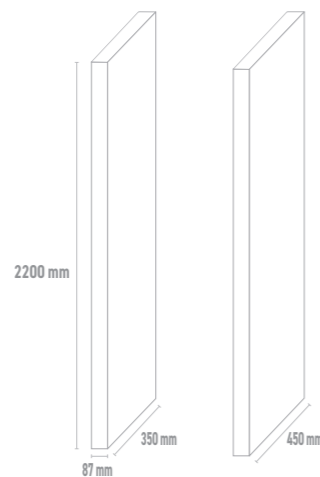

LUMBERTECH MODULAR HORIZONTAL



H_87 mm
L_2200 mm
P_350 mm monofacciale
P_450 mm bifacciale



2200 mm è la misura standard. Si possono configurare dimensioni inferiori secondo il proprio progetto.

2200 mm is the standard size. Smaller sizes can be configured according to your project.

Soluzioni Arredative / Interior Design Solutions

Per la prima volta **pavimento e arredo** sono frutto dello stesso progetto. I componenti sono doghe per pavimento o sono elementi per costruire arredi. Stessa materia, stesso lotto produttivo.

For the first time, **floor and furniture** are the result of the same project. The components are floor planks or are elements to build furniture. Same material, same production batch.

ESEMPI EXAMPLES		DIMENSIONE SIZE		VERTICAL	HORIZONTAL	FINITURE FINISHING	FINITURE FINISHING
		MONOFACCIALE SINGLE SIDE	BIFACCIALE DOUBLE SIDES	ELEMENTI ELEMENTS	ELEMENTI ELEMENTS	VARNISH	OIL
BOOKCASES 1		2380x2200x87	2200x450x87	2	3	8	7
BOOKCASES 2		4670x2200x350	4670x2200x450	3	6	8	7
BENCH			2200x450x450	2	1	8	7
TABLE			1100x450x650	2	1	8	7
PARETE CANNETTATA RIBBED WALL		CUSTOM	-	-	8	7	



Accessori

Accessories

Sottopavimenti Underlayers	32
Battiscopa Skirting Boards	33
Profili profiles	34
Accessori vari Various accessories	36
Prodotti Manutenzione Maintenance products	36

PRODOTTO - PRODUCT	DIMENSIONE - SIZE	DESCRIZIONE - DESCRIPTION
<p>SUPERIOR RBR SUPERIOR RBR</p> 	<p>ROTOLO DA 8 m² 8 m² ROLL</p> <p>1000 mm - 2 mm</p>	<p>Sottopavimento dalle performance elevate costituito da un'alta percentuale di cariche minerali unite da legante poliuretano, con densità media di 800 kg/m³, soddisfa ampiamente lo standard EPLF emanato per i sottopavimenti. In particolare SUPERIOR RBR ha ottima resistenza meccanica CS che protegge l'incastro, ha elevate caratteristiche acustiche IS, in particolare per la riduzione del riverbero del rumore in stanza RWS e bassa resistenza termica TR essendo così fortemente consigliato per la posa su massetti radianti; Superior RBR è integrato da una barriera vapore (PET/alluminio) ed è infine un prodotto che non contiene sostanze pericolose ed è a bassissima emissione di composti organici volatili (COV). Posare il lato in PET/alluminio verso l'alto. Vedi scheda tecnica per la descrizione tecnica completa.</p> <p>High-performance underlay made with a high percentage of mineral fillers combined with polyurethane binder, with an average density of 800 kg/m³, which largely meets the EPLF standard issued for underlays. In particular, SUPERIOR RBR has an excellent CS mechanical resistance that protects the joint, elevated IS acoustic characteristics, in particular for the reduction of noise reverberation in the RWS room and low TR thermal resistance, making it so strongly recommended for installation on radiant subfloors; Superior RBR is equipped with a vapour barrier (PET/aluminium) and it is a product that does not contain dangerous substances, having also a very low emission of volatile organic compounds (VOC). Lay the PET/aluminium side upwards. See technical data sheet for full technical description.</p>
<p>SOTTOPAVIMENTO DB DB UNDERLAYER</p> 	<p>ROTOLO DA 25 m² 25 m² ROLL</p> <p>1000 mm - 2 mm</p>	<p>Sottopavimento dalle performance medie costituito da una schiuma poliolefinica a celle chiuse estrusa in modalità controllata con densità media di 80 kg/m³. DB soddisfa lo standard EPLF emanato per i sottopavimenti. In particolare DB ha buone performance di resistenza meccanica CS, ha buon isolamento al rumore da calpestio IS ed è integrato da una barriera vapore SD (PET) che evita la diffusione dell'umidità dal sottofondo al pavimento ed è dotato di una cimosa laterale con nastro adesivo preapplicato per la congiunzione dei materassini. DB è prodotto senza CFC (clorofluorocarburi) e HCFC (idrofluorocarburi) e non contiene né plastificanti né metalli pesanti o altre sostanze pericolose. Posare il lato nero con la barriera vapore rivolto verso l'alto. Vedi scheda tecnica per la descrizione completa delle caratteristiche.</p> <p>Underlay with average performance made with a closed-cell polyolefin foam extruded in controlled mode with an average density of 80 kg/m³. DB meets the EPLF standard issued for underlays. In particular, it has good CS mechanical resistance performance, good IS insulation against footsteps noise and is supplemented by an SD (PET) vapour barrier that prevents the diffusion of moisture from the subfloor to the floor and is equipped with a side selvedge with pre-applied adhesive tape to join the underlay. DB is produced without CFCs (chlorofluorocarbons) and HCFCs (hydrofluorocarbons) and does not contain plasticizers, heavy metals or other dangerous substances. Lay the black side with the vapour barrier facing upwards. See data sheet for full description of the characteristics.</p>

PRODOTTO - PRODUCT	DIMENSIONE - SIZE	DESCRIZIONE - DESCRIPTION
<p>BATTISCOPA STAR STAR SKIRTING BOARD</p> 	<p>H 60 2400x60x12 mm</p>	<p>Questo profilo battiscopa è in HDF. Le sue proporzioni standard (60 mm di altezza per 12 mm di base) lo rendono ideale per la finitura perimetrale del pavimento in locali piccoli e nelle abitazioni in genere.</p> <p>This skirting profile is made of HDF. Its standard proportions (60 mm high by 12 mm base) make it ideal for perimeter floor finishing in small rooms and in homes in general.</p>
<p>BATTISCOPA TIME TIME SKIRTING BOARD</p> 	<p>H 80 2400x80x14 mm</p>	<p>Questo profilo battiscopa è in HDF con decorativi di tendenza. E' consigliabile l'uso in locali di ampia dimensione, sia per l'impatto estetico (è caratterizzato infatti da una maggiore altezza - 80 mm) che per la funzionalità (la base leggermente più ampia - 14 mm consente di lasciare più spazio ai bordi, tra il pavimento e la parete).</p> <p>HDF skirting board with trendy modern design decors and poro finishing. It is suitable for large environments for its aesthetic impact (80 mm of height) and functionality (the thickness of 14 mm allows more dilatation space between floors and walls).</p>
<p>BATTISCOPA LOOK LOOK SKIRTING BOARD</p> 	<p>H 45 2200x45x14 mm 2400x45x14 mm</p>	<p>Questo profilo battiscopa è in HDF con decorativi di tendenza dal design moderno e finitura poro. E' studiato per ambienti sia pubblici che privati che richiedano la massima resa estetica e prestazionale, è caratterizzato infatti da una altezza inferiore, 45 mm per 14 mm di base.</p> <p>HDF skirting board with trendy modern design and poro finishing. It's developed for both public and private environments requiring the maximum aesthetic and technical performance. It's in fact characterized by a lower height of 45 mm and base of 14 mm.</p> <p>* la dimensione 2200 mm viene fornita fino ad esaurimento scorte * the 2200 mm size is supplied while stock lasts</p>

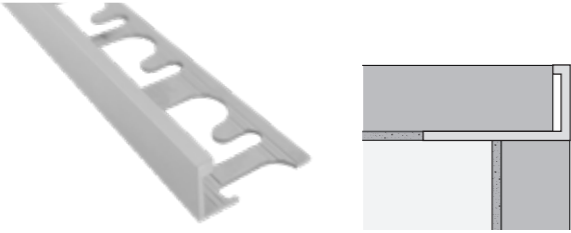
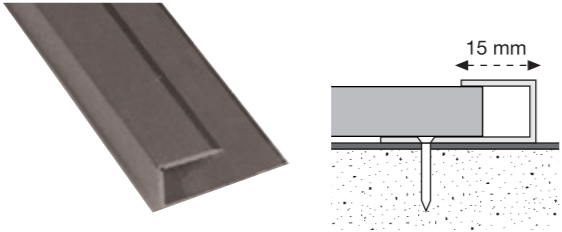
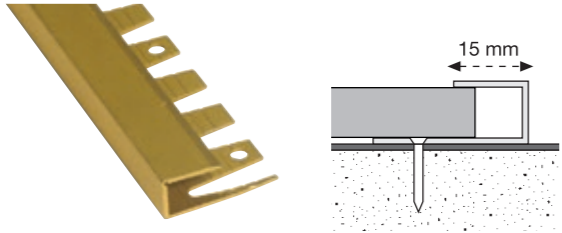
PRODOTTO - PRODUCT		DIMENSIONE - SIZE	DESCRIZIONE - DESCRIPTION
PROFILO SCALA LUMBERTECH LUMBERTECH STAIR PROFILE		2700x 11mm	<p>Profilo scala ad L in alluminio anodizzato argento, per rivestire i gradini con le stesse doghe utilizzate per realizzare il pavimento (da incollare).</p> <p>Silver anodized aluminum L-shaped profile to cover the steps with the same planks used for the flooring (to be glued).</p>
PROFILO DI BORDO BORDER PROFILE		2700x15x9 mm 2700x15x11 mm	<p>Profilo in alluminio estruso per bordature perimetrali per pavimenti.</p> <p>Extruded aluminium profile for perimeter edging for floorings.</p>
PROFILO DI BORDO CURVABILE CURVABLE BORDER PROFILE		2700x15x9 mm 2700x15x11 mm 2700x15x13 mm	<p>Profilo in alluminio estruso curvabile per bordature perimetrali.</p> <p>Extruded curvable aluminium profile for perimeter edging.</p>

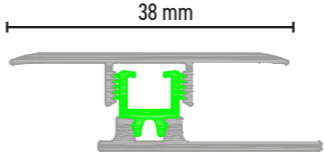
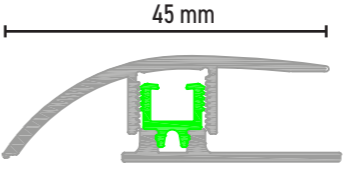
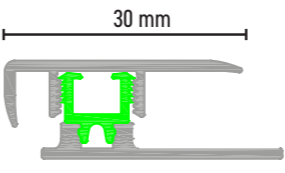



PRODOTTO - PRODUCT		DIMENSIONE - SIZE	SPESSORE PAVIMENTO THICK FLOORING	DESCRIZIONE - DESCRIPTION
KIT DILATAZIONE EXPANSION KIT		2700x38 mm	9>12,5 mm	<p>Kit dilatazione abbinabile e in alluminio con Pin Unico per pavimenti con spessore da 6 a 12,5 mm, con base femmina in alluminio.</p> <p>Aluminum expansion kit with Single Pin for floorings with thickness from 6 to 12,5 mm and aluminum female base.</p>
KIT DISLIVELLO SPLICE KIT		2700x45 mm	9>12,5 mm	<p>Kit dislivello in alluminio con Pin Unico per pavimenti con spessore da 9 a 12,5 mm con base femmina in alluminio.</p> <p>Aluminum splice kit with Single Pin for floorings with thickness from 9 to 12,5 mm and aluminum female base.</p>
KIT TERMINALE TERMINAL KIT		2700x30 mm	9>12,5 mm	<p>Kit terminale in alluminio con Pin Unico per pavimenti con spessore da 9 a 12,5 mm, con base femmina in alluminio.</p> <p>Aluminum expansion kit with Single Pin for floorings with thickness from 9 to 12,5 mm and aluminum female base.</p>

PRODOTTO - PRODUCT	DIMENSIONE - SIZE	DESCRIZIONE - DESCRIPTION
CLIP DI AGGANCIAMENTO RETAINING CLIPS 	44x41 mm Confezione / Packaging 200 pz / pcs	La clip di aggancio zincata nera è l'elemento metallico che incastrandosi per rotazione sull'omega fissa il pannello e le doghe alla struttura. Per K-uno Hydro Plus, Prestige L Hydro e Lumbertech. The black galvanized attachment clip is a metal piece that clips onto the omega strip by rotation and fastens the panels to the supporting structure. For K-uno Hydro Plus, Prestige L Hydro and Lumbertech.
PROFILO OMEGA OMEGA PROFILE 	3000x25x26 mm 3000x13x26 mm * Confezione / Packaging 1pz / pcs	Il profilo ad omega costituisce l'elemento per il fissaggio a parete, tramite viti o tasselli deve essere montato ad una struttura portante tipo cartongesso o al muro da rivestire. Omega cross-section profile is the element that fastens the boards to the wall. It must be installed using screws or wall plugs to a load bearing structure, such as drywall or the wall to be covered.

* Questo profilo omega a spessore ridotto 13 mm non è compatibile con i prodotti fonoassorbenti in quanto non c'è lo spazio sufficiente per l'inserimento del materassino da 20 mm.
 * This Omega profile with reduced thickness of 13 mm is not suitable with sound-absorbing products since there is not enough space for placing the 20 mm pad.

Prodotti di Pulizia_Cleaning Products

DESCRIZIONE - DESCRIPTION	PRODOTTO - PRODUCT	DIMENSIONE - SIZE
Dedicati ai pavimenti Sistema e Lumbertech. Dedicated to Sistema and Lumbertech floors.	 LUMBERTECH: PULISYSTEM	DETERGENTE IGIENIZZANTE / SANITIZING DETERGENT PULISYSTEM 1 LITRO / LITRE

DESCRIZIONE - DESCRIPTION	PRODOTTO - PRODUCT	DIMENSIONE - SIZE
LUMBERTECH OIL: PULIZIA, MANUTENZIONE E RIPRISTINO CLEANING, MAINTENANCE AND RESTORATION 	PULIZIA PERIODICA / PERIODIC CLEANING MANTENIMENTO PERIODICO / PERIODIC MAINTENANCE RITOCO E RIPRISTINO / TOUCHING UP AND RESTORATION	PARKETTREINIGER SAPONE DETERGENTE PARQUET 1 LITRO / LITRE DETERGENTE MANUTENTORE CEROSO 1 LITRO / LITRE OLIO PER RITOCO 0,125 LITRO / LITRE
LUMBERTECH OIL: TRATTAMENTO SPECIALE DI OLIATURA SPECIAL OILING TREATMENT 	Prodotti specifici per oliatura. Specific products for oiling.	OSMO POLYX OIL 3062 MATT TRATTAMENTO SPECIALE DI OLIATURA A NECESSITÀ SPECIAL OILING TREATMENT BY NECESSITY 0,75 LITRO / LITRE 2,5 LITRO / LITRE
LUMBERTECH VARNISH: PULIZIA E MANUTENZIONE CLEANING AND MAINTENANCE 	Prodotti specifici per la pulizia e manutenzione dei prodotti della linea Lumbertech varnish. Fare riferimento alle schede di manutenzione per il metodo di impiego. Specific products for the cleaning and maintenance of Lumbertech varnish collection products. Refer to maintenance sheets for the method of use.	PULIZIA PERIODICA / PERIODIC CLEANING CLEANER STAR 1 LITRO / LITRE
LUMBERTECH OIL / VARNISH: WAX CARE SPRAY 	Prodotti specifici per la pulizia e manutenzione dei prodotti della linea Lumbertech varnish. Fare riferimento alle schede di manutenzione per il metodo di impiego. Specific products for the cleaning and maintenance of Lumbertech varnish collection products. Refer to maintenance sheets for the method of use.	MANTENIMENTO PERIODICO / PERIODIC MAINTENANCE WAX CARE 1 LITRO / LITRE
LUMBERTECH: SANITOTAL 	Dedicati ai pavimenti Sistema e Lumbertech. Dedicated to Sistema and Lumbertech floors.	DETERGENTE DECONTAMINANTE DECONTAMINATION DETERGENT SANITOTAL 1 LITRO / LITRE

ATTENZIONE: DA UTILIZZARSI DOPO AVER LAVATO LE SUPERFICI CON IL PRODOTTO PULISYSTEM
ATTENTION: TO BE USED AFTER WASHING THE SURFACES WITH THE PULISYSTEM PRODUCT

CLASSE LIBERA

Faccia dell'elemento

CARATTERISTICHE	NATURE	AMBIENTE / COMFORT	RUSTICO
Alburno sano	Minima presenza	Piccola presenza	Possibile presenza
Nodi (sani ed aderenti)	Minima presenza	Media presenza	presente
Nodi (morti, vuoti, stuccati)	Minima presenza	Media presenza	presente
Nodi occhi di pernice	Presente	Presente	presente
Alterazioni di colore giallo	Possibile presenza	Possibile presenza	Possibile presenza
Cretti (stuccati)	Non rilevanti	Possibile presenza	presenti
Inclusioni di corteccia	Assenti	Assenti	Minima presenza
Colpo di fulmine	Possibile presenza	Possibile presenza	Possibile presenza
Fibratura aggrovigliata	Minima presenza	Piccola presenza	Piccola presenza
Deviazione della fibratura	presente	presente	presente
Cuore sano/rosso	Non rilevante	Non rilevante	Non rilevante
Variazioni di colore	minima presenza	piccola presenza	presente
Tracce di listelli	minima presenza	minima presenza	minima presenza
Raggi parenchimatizi (specchiature)	Possibile presenza	Possibile presenza	Possibile presenza
Alterazione biologica	Possibile presenza	Minima presenza	Minima presenza

Parti non visibili

Tutte le caratteristiche sono consentite senza alcun limite di dimensioni o quantità se non compromettono la resistenza o la qualità di resistenza all'usura delle pavimentazioni di parquet.

FREE CLASS

Face of the element

FEATURES	NATURE	AMBIENTE / COMFORT	RUSTIC
Sound sapwood	Minimal presence	Small presence	Possible presence
Knots (live)	Minimal presence	Medium presence	Present
Knots (dead, hole)	Minimal presence	Medium presence	Present
Pin knots	Present	Present	Present
Yellow stain	Possible presence	Possible presence	Possible presence
Cheks	Not relevant	Possible presence	Present
Bark pockets	Absent	Absent	Minimal presence
Lightning shake	Possible presence	Possible presence	Possible presence
Curley grain	Minimal presence	Small presence	Small presence
Slope grain	Present	Present	Present
Sound heart	Not relevant	Not relevant	Not relevant
Colour variation	Minimal presence	Small presence	Present
Stick marks	Minimal presence	Minimal presence	Minimal presence
Medullary ray	Possible presence	Possible presence	Possible presence
Biodeterioration	Possible presence	Minimal presence	Minimal presence

Non-visible parts

All features permitted without any limitation as to size or quantity if these do not impair the strength or wearing quality of the parquet flooring.



Lumbertech
Varnish S700
Valsesia

Tabella Logistica _Logistics Data Table

	Dimensioni Dimension	doghe per confezione Pcs/Box	Superficie mq per confezione* Sqm per box*	Dimensioni confezione Box dimensions	Peso per confezione Box Weight	Confezione per pallet Boxes per pallet	Superficie mq per pallet* Sqm per pallet*	Dimensione pallet quan- do intero Pallet dimensions	Peso al mq Weight per sqm	Peso lordo pallet Pallet Weight
	mm	n	mq sqm	mm	kg	n	mq sqm	mm	kg	kg
LUMBERTECH										
LUMBERTECH OIL 270	2200x270x11	4	2,376	2235x295x49	23,46	30	71,280	2250x900x480	9,87	719
LUMBERTECH VARNISH 270	2200x270x11	4	2,376	2235x295x49	23,46	30	71,280	2250x900x480	9,87	719
LUMBERTECH VARNISH S700	700x140x11	10	0,980	730x160x120	10,36	56	54,880	1200x760x900	8,90	559
LUMBERTECH VARNISH 205	2200x205x11	4	1,804	2230x210x50	20,00	40	72,160	2250x920x570	11,12	790

I valori espressi sono calcolati considerando i decimi di millimetro / The values indicated are calculated considering the tenths of a millimeter.

I dati tecnici possono subire modifiche senza obbligo di preavviso / Technical details may be changed without any previous warning

IMPORTANTE

Il programma **LUMBERTECH** è di origine totalmente naturale e quindi la materia può presentare distonie cromatiche, differenze di pasta lignea, variazioni di tonalità per i processi di ossidazione e variazioni nei formati e negli spessori.

Queste sono da considerarsi caratteristiche e non difetti.

I dati tecnici possono subire modifiche senza obbligo di preavviso. Per ulteriori informazioni o dati tecnici contattare il nostro ufficio tecnico, oppure visitare il sito www.skema.eu.

ATTENZIONE: Per l'installazione dei pavimenti Lumbertech in luoghi particolarmente sensibili come bagni non ventilati o zone umide, è necessario seguire attentamente le istruzioni di posa e, se necessario, utilizzare un trattamento aggiuntivo con un prodotto idrorepellente.

IMPORTANT

LUMBERTECH program is totally natural origin, therefore the matter may present chromatic dystonias, differences in woody pulp, variations in tones for the oxidation processes & variations in formats & thicknesses.

These are to be considered characteristics & not defects.

Technical details may be modified without any prior warning. For further information or other technical details, please contact Skema technical office or visit www.skema.eu.

CAUTION: When installing Lumbertech floors in particularly sensitive locations such as unventilated bathrooms or wet areas, you must carefully follow the installation instructions and, if necessary, use an additional treatment with a water-repellent product.



SKEMA®



SKEMA S.p.A.
ITALY

T +39 0422 858511
skema.eu - info@skema.eu

952.0050#1G
ITA - ING