

Flut



GSG
CERAMIC DESIGN

L'azienda **Company Profile**

GSG Ceramic Design considera elementi base del suo percorso creare ceramiche che possano, con la loro forte personalità, creare/evocare stimolanti suggestioni.

La continua ricerca estetico-tecnica ha portato questa piccola azienda ad essere conosciuta internazionalmente con una ben precisa immagine.

Questo risultato è dovuto sia al talento artistico di Massimiliano Abati per la sua innovativa proposta formale sia alla professionalità dell'Azienda maestra nell'innovare costantemente nel solco di una grande tradizione tecnica.

Gli oggetti prodotti sono esclusivi e carichi di significati intellettuali. Il loro utilizzo conduce a scenari estetici inesplorati.

Piccole ma grandi opere aperte.

GSG Ceramic Design considers basic elements of his personal path to create ceramics that they can with their strong personalities create / evoke stimulating suggestions. The continuous aesthetic and technical research has led this small company to be known internationally with a very specific image.

This result is due both to the artistic talent of Massimiliano Abati for his innovative formal proposal and to the company's professionalism with his constantly innovating in the wake of a great technical tradition.

The produced items are exclusive and plenty of intellectual meanings.

Their choice leads any user to aesthetic scenarios still unexplored.

Small but big open works.

GSGi
CERAMIC DESIGN

Processo produttivo Manufacturing process

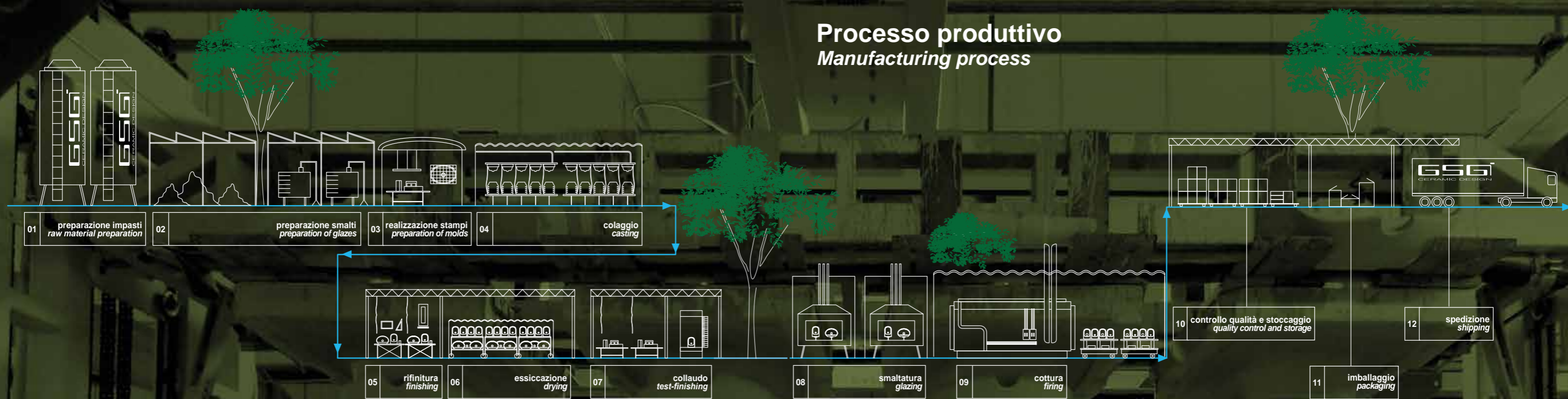

01	02	03	04	05	06	07	08	09	10	11	12
preparazione impasti raw material preparation	preparazione smalti preparation of glazes	realizzazione stampi preparation of molds	colaggio casting	rifinitura finishing	essiccazione drying	collaudo test-finishing	smaltatura glazing	cottura firing	controllo qualità e stoccaggio quality control and storage	imballaggio packaging	spedizione shipping

01 preparazione impasti raw material preparation
L'utilizzo di materie prime di primaria qualità, permettono di ottenere gli impasti comunemente usati per la ceramica sanitaria: Vetro China, ottenuta con l'utilizzo di alte percentuali di caolino e quarzo, che la rendono più pura e fine, e Fire Clay, ottenuto utilizzando meno caolino e più materiali inerti.

02 preparazione smalti preparation of glazes
L'alta qualità degli smalti adoperati è garantita dai continui tests a cui vengono sottoposti, per esprimere al meglio la corretta sintonia con il supporto ceramico, l'adeguata corrispondenza della tonalità di colore e le caratteristiche di resistenza che le normative impongono.

03 realizzazione stampi preparation of molds
GSG Ceramic Design utilizza solo gesso di altissima qualità per la realizzazione dei suoi stampi. Il gesso permette, mediante il principio di assorbimento d'acqua, di creare le condizioni affinché il prodotto, nella sua prima fase di lavorazione, possa essere facilmente isolato.

04 colaggio casting
Gli impasti precedentemente preparati, Vetro China o Fire Clay, vengono iniettati, manualmente o con l'ausilio di appositi macchinari, all'interno degli stampi in gesso mediante i quali, per mezzo del principio di assorbimento d'acqua, si ottiene il prodotto prefinito avente il giusto spessore della materia.

05 rifinitura finishing
La prima fase di rifinitura è a cura di mastri esperti che, manualmente, rimuovono ogni imperfezione dovuta ad esempio ad impasto eccedente nelle giunture tra i pezzi dello stampo o ad altre cause nel processo di modellazione. Eventuali articoli non idonei agli alti standard GSG saranno rimossi dalla produzione e riutilizzati come materiale da reimpasto.

06 essiccazione drying
Per ridurre in modo importante il processo di asciugatura dei prodotti senza tuttavia comprometterne l'integrità cioè senza provocare fessurazioni, essi vengono trasportati in un essiccatoio automatico dove viene forzata in modo controllato una rapida e significativa perdita d'acqua e quindi di peso.

07 collaudo test-finishing
I prodotti vengono sottoposti ad una ulteriore fase di rifinitura, sempre manuale, ancora più attenta e approfondita, al fine di ottenere prodotti privi di imperfezioni.

08 smaltatura glazing
La smaltatura, effettuata manualmente da mastri smaltatori, è applicata a tutte le superfici esterne ed interne di ogni articolo, evitando accuratamente che in ogni prodotto rimangano parti non smaltate.

09 cottura firing
I prodotti smaltati attentamente caricati sulle strutture vengono inviati al forno per la cottura. In GSG il ciclo di cottura ha una durata di ca. 22 ore e segue un preciso programma di fasi tutte determinanti per l'ottenimento di un risultato finale ottimale. I prodotti sono pre-riscaldati, quindi portati lentamente alla temperatura di cottura che in GSG è 1250° C., quindi passano alla fase di "permanenza" ed infine al raffreddamento.

10 controllo qualità e stoccaggio quality control and storage
I prodotti selezionati e corrispondenti agli standard GSG vengono stoccati nel nostro magazzino. I prodotti sono suddivisi per serie, tipologia e colore o decorazione. Tutto il magazzino è controllato on time dal nostro sistema di gestione per poter rispondere tempestivamente e correttamente alle richieste della clientela.

11 imballaggio packaging
Ogni articolo viene singolarmente scatolettato, posto sul pallet e avvolto da una pellicola protettiva in PVC termoretroabile.

12 spedizione shipping
I nostri prodotti sono tutti pallettizzati per la loro sicurezza e facilità di trasporto. GSG è in grado di caricare pallet su qualsiasi mezzo di trasporto su gomma con pianale e di predisporre containers sia di 20' che 40'.

The use of finest quality raw materials, permits us to use fewer inert materials: Vitreous China is made with high percentages of kaolin and quartz, making it purer and finer. Fire Clay is obtained using less kaolin and more inert materials.

The high quality of glazes used is always being tested continually giving a correct harmony for the ceramic production, a guarantee of colour tones and resistance that international standards require.

GSG Ceramic Design uses only the highest quality plaster for the construction of its molds. Plaster allows, by means of the principle of water absorption, to create the conditions so that the product, in its first stage of processing, it can be easily isolated.

Vitreous China or Fire Clay previously prepared, are injected, manually or with the aid of suitable machinery, to the interior of plaster molds, by means of the principle of water absorption, the product is obtained prefinished and having the right thickness of the material.

The first stage of finishing is curated by expert masters that, manually, remove all imperfections due for example to excess dough in the joints between the pieces of the mold or other causes in the modeling process. Any items not suitable to the GSG high standards will be removed from production and reused as material for re-mix.

To drastically reduce the drying process of the products without compromising their integrity that is, without causing cracks, they are transported in an automatic dryer where it is forced in a controlled manner a rapid and significant loss of water and therefore weight.

Any item it's subjected to a further step of finishing, always manual, even more careful and thorough, in order to obtain products free of imperfections.

Glazing, hand made by master glazers, is applied to all external and internal surfaces of each item, carefully avoiding that in every product remain unglazed parts.

The glazed products carefully loaded on the wagons are sent to the kiln for firing. In GSG the firing cycle has a duration of about 22 hours, following a precise schedule of all phases determinants for obtaining an optimum end result. The products are pre-heated, then slowly brought to the firing temperature which GSG is 1250 °C., then pass to the phase of "permanence" and finally to the cooling.

Products selected and meeting the GSG standards are stored in our warehouse. The products are subdivided in series, type and color or decoration. All warehouse it's controlled on time by our management system in order to respond promptly and correctly to our customers' requests.

Each item is separately packed in a single cardboard box, placed on pallets and wrapped in protective PVC shrink film.

Our products are all palletized for their safety and ease of transport. GSG is able to load pallets on any means of transport on the platform with rubber and to prepare both containers 20' to 40'.

Plus tecnologici per la collezione FLUT
Technological Plus for FLUT collection



SMART
CLEAN
INTELLIGENT FLUSHING SYSTEM



wc bidet



3lt 4,5lt

saving water

Plus wc FLUT

Plus tecnologici per la collezione FLUT
Technological Plus for FLUT collection



avvolgente
wrapover



slim



soft close



sgancio rapido
quick release

Plus coprivaso - seat cover FLUT

Caratteristiche lavabi
Washbasins features



appoggio
countertop



sospeso
wall-hung



free standing



monoforo - tre fori
one hole - three holes

06

Smart Clean

08

Collezioni / Collections FLUT

42

Schede tecniche Flut e lavabi
Technical measurements Flut
and washbasins

Smart clean

Sistema di scarico Smart Clean
Intelligent flushing system

SMART CLEAN è il nuovo ed innovativo sistema di scarico realizzato da GSG Ceramic Design. Grazie alla forma della sezione del vaso, l'acqua compie un percorso rotatorio che garantisce una pulizia più efficace. Con l'eliminazione della brida l'acqua viene convogliata direttamente sull'area interessata, evitando formazioni batteriche in aree nascoste e difficilmente raggiungibili.

Il sistema SMART CLEAN è disponibile nelle versioni LIKE, BRIO, TOUCH e FLUT.

La pulizia delle superfici esterne del vaso, è facilitata dal sistema a sganciamento rapido del coprivaso che avviene attraverso il pulsante di rilascio, un semplice gesto senza utensili.

Il sistema a sganciamento rapido è disponibile per le nuove collezioni LIKE, BRIO, OZ e FLUT.

ALTI STANDARD IGIENICI - FACILITA' DI PULIZIA - MAGGIORE COMFORT.

SMART CLEAN is the new and innovative flushing system made by GSG Ceramic Design. The particular form of the section of the WC makes the water flush in rotatory motion which guarantees a more effective cleaning. With the elimination of the rim, water is forced directly to the proper area, avoiding bacterial formations in hidden areas and difficult to reach.

SMART CLEAN system is available in versions LIKE, BRIO, TOUCH and FLUT.

Clean the outer surface of the vessel, it is facilitated by the quick release system seat cover which occurs through the release button, a simple gesture without tools.

The quick release system is available for the new LIKE, BRIO, OZ and FLUT collections.

HIGH STANDARD - TOILET EASY CLEANING - GREATER COMFORT.



Wc Flut Smart Clean



Cod. FLWC01
Wc Flut Terra
Wc Flut Back To Wall



Collezione **Flut**

Concept Flut

Flut: Il nuovo concept bath di GSG Ceramic Design, rilegge la contemporaneità attraverso codici stilistici appartenenti al nostro immaginario storico. Una rievocazione di linee archetipiche che "mai" hanno abbandonato la nostra quotidianità. Il catino; il vaso sul comò; il bicchiere a calice; la tazza da the; tutta l'oggettistica primi novecento. E tornando ancora indietro nel tempo, tutti i codici degli ordini architettonici della classicità greca. Declinata nella versione a terra (wc e bidet), e corredata da con una gamma di lavabi sospesi ed appoggio, dalle linee raffinate ed evocative. Un nuovo modo di rileggere la nostra memoria delle forme, che irrompe nella contemporaneità con la sua citazione costante del "tempo".

Flut: the new concept of a bathroom, by The GSG Ceramic Design. A contemporary vision through our historic imagination. Architectural lines used during our daily life, a bowl, a vase on a dressing table, a goblet and a tea cup, objects from the early 19th century, going back in time, our memory leads us to a classical Greece. Declining all our styles: W.C and bidet back to wall W.C., together with a variety of washbasins, wall hung and back to wall in different measurements, evocative and elegant designs. A new way to evoke our memory of forms that become contemporary reminding us of "time" defining a classic image.

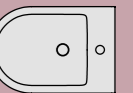
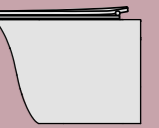
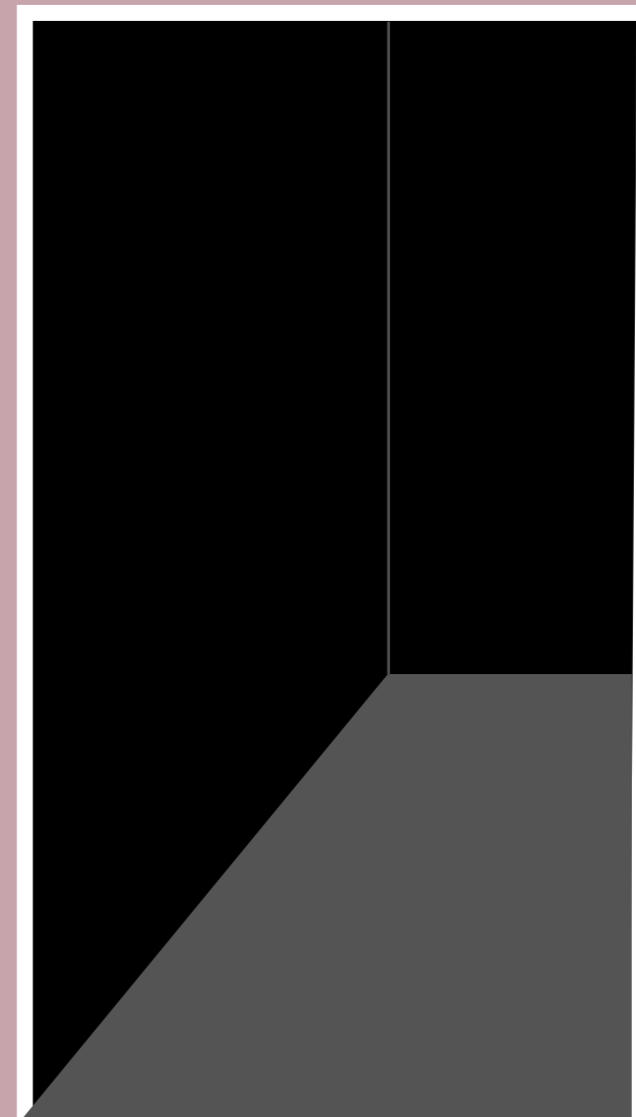

Flut

Versione a terra *Back to wall*



Flut

Classico contemporaneo
Contemporary classic



Bidet Flut a terra
Bidet Flut back to wall
Cod. FLBI01

Wc Flut a terra
Wc Flut back to wall
Cod. FLWC01



Flut

Versione a terra *Back to wall*



Flut

Classico contemporaneo
Contemporary classic



Wc Flut a terra
Wc Flut back to wall
Cod. FLWC01

Bidet Flut a terra
Bidet Flut back to wall
Cod. FLBI01



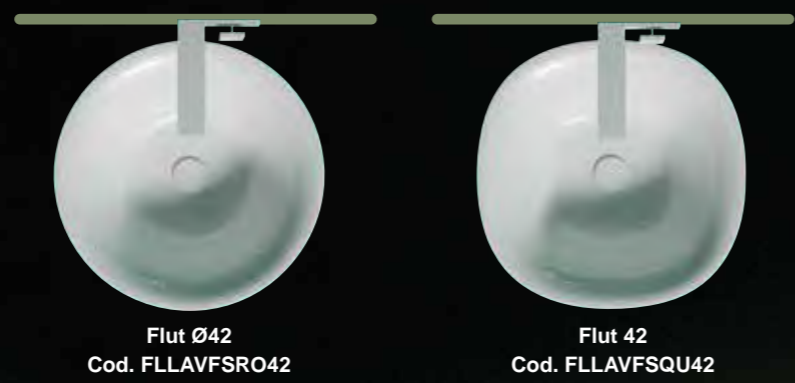

Flut Ø42
Cod. FLLAVFSRO42

Flut 42
Cod. FLLAVFSQU42

Flut

Collezione lavabi bordo sottile
Thin edge washbasins collection



Lavabo Flut 42
Flut washbasin 42
Cod. FLLAVFSQU42



Flut 42
Cod. FLLAVFSQU42



Flut Ø42
Cod. FLLAVFSRO42



Flut

Collezione lavabi bordo sottile
Thin edge washbasins collection



Lavabo Flut 65
Flut washbasin 65
Cod. FLLAVBW65



Flut 80x48
Cod. FLLAVBW80



Flut 65x48
Cod. FLLAVBW65

Flut

Versione a terra *Back to wall*



Flut

Classico contemporaneo
Contemporary classic



Bidet Flut a terra
Bidet Flut back to wall
Cod. FLBI01

Wc Flut a terra
Wc Flut back to wall
Cod. FLWC01



Flut





Flut

Collezione specchi
Mirrors collection

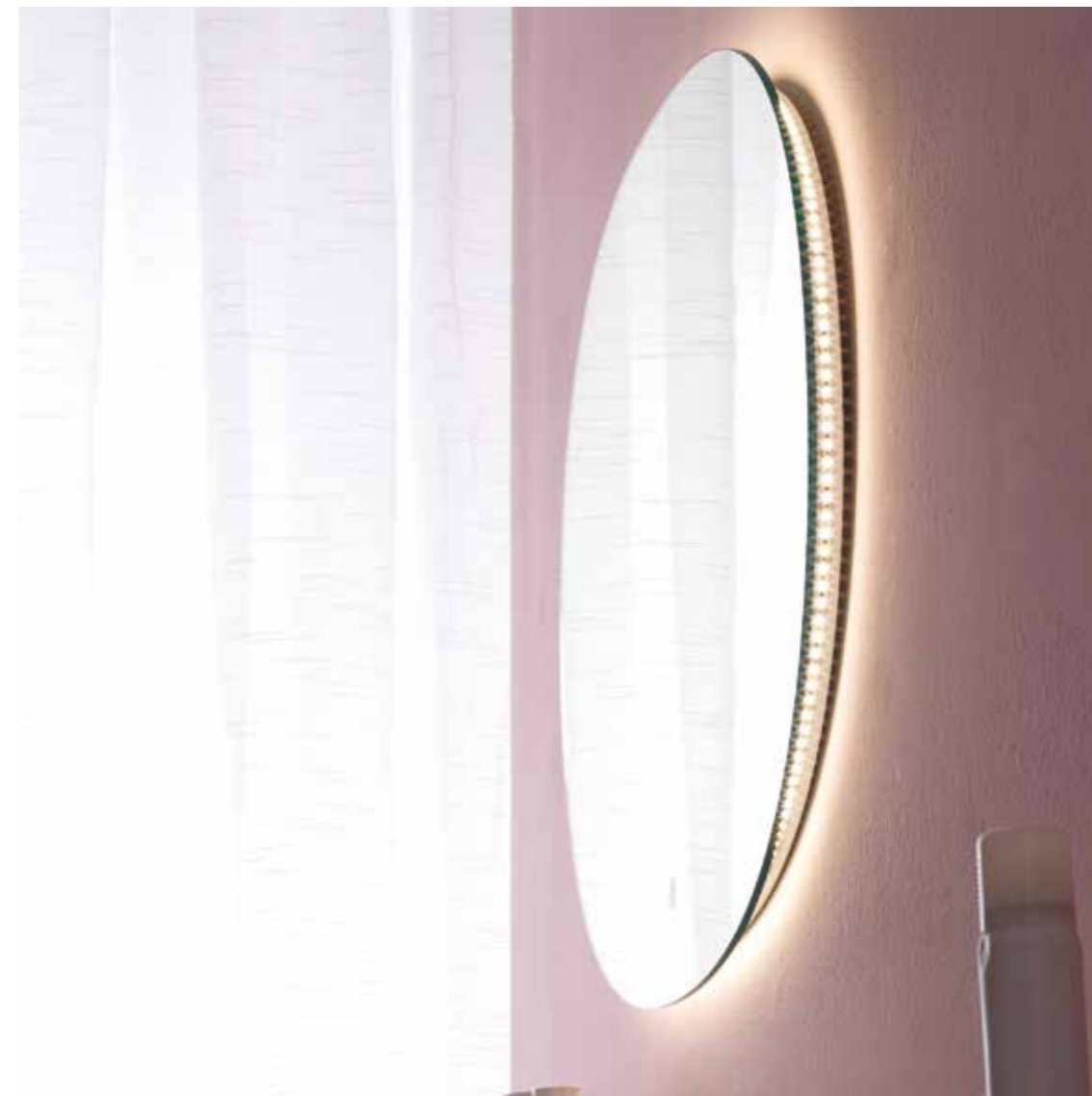

Specchio 65
Cod. FLSP65



Specchio 65 led
Cod. FLSP65RI



Specchio 90
Cod. FLSP90



Specchio 90 led
Cod. FLSP90RI

Fill

Accessori Accessories

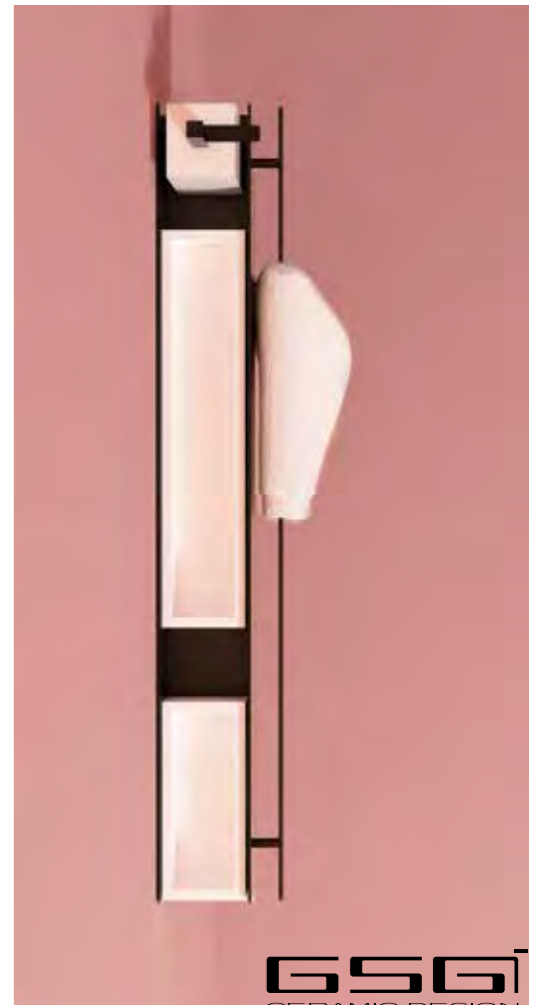

Fill

Accessori Accessories

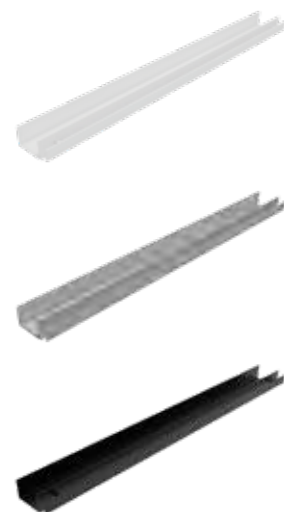

Mensola 120 cm acciaio verniciato
Shelf in painted steel cm. 120
Cod. FIMEVE120



Mensola 80 cm acciaio verniciato
Shelf in painted steel cm. 80
Cod. FIMEVE80



Mensola 60 cm acciaio verniciato
Shelf in painted steel cm. 60
Cod. FIMEVE60



Mensola 40 cm acciaio verniciato
Shelf in painted steel cm. 40
Cod. FIMEVE40



Fill

Contenitori Accessories



Contenitore in ocritec 20 cm
Case in Ocritec cm. 20
Cod. FISC20



Contenitore in ocritec 40 cm
Case in Ocritec cm. 40
Cod. FISC40

Ingombri Measure



COD FLBI01

COD FLWC01

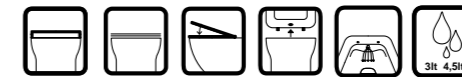

Wc Flut a terra Wc Flut back to wall
Bidet Flut a terra Bidet Flut back to wall

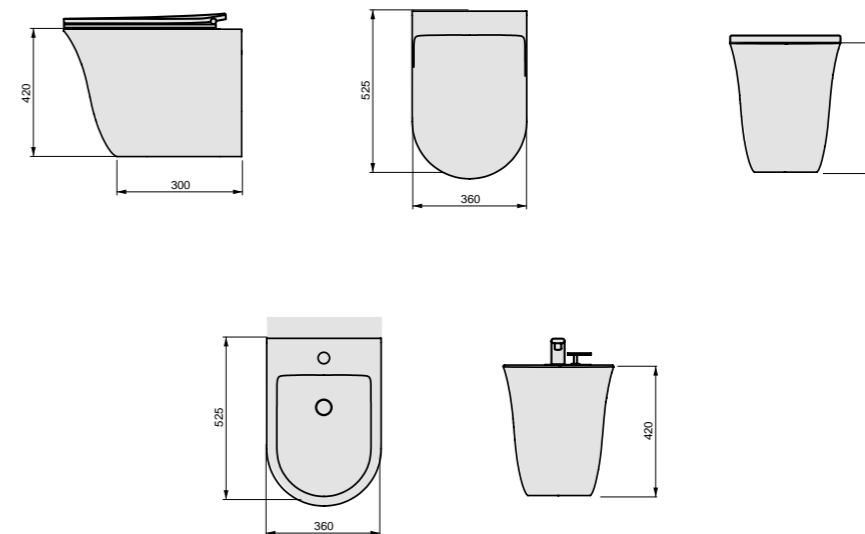

Flut e Fill

Classico contemporaneo
Contemporary classic



Mensola Fill cm 60
Fill shelv cm 60
Cod. FIMEV60

Specchio Flut cm 90 retroilluminato
Mirror Flut cm 90 led
Cod. FLSP90RI

Ingombri Measure



COD FLSP65RI



COD FISC20



COD FISC40

COD FIMEV80

Specchio Flut Flut mirror

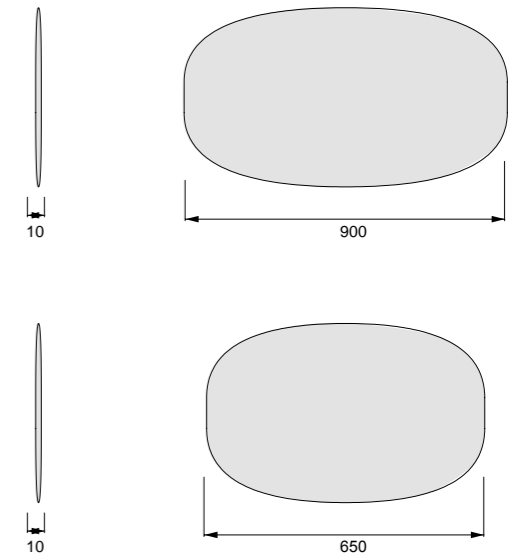

Contentori Fill Fill Shelves

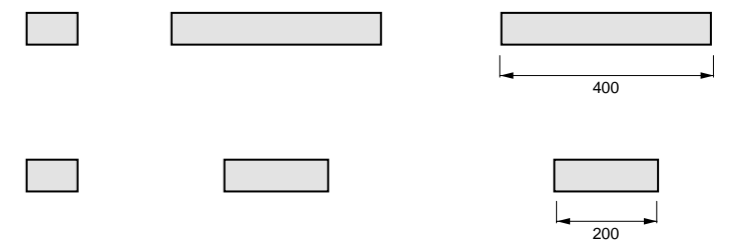

Mensole Fill Fill Shelves

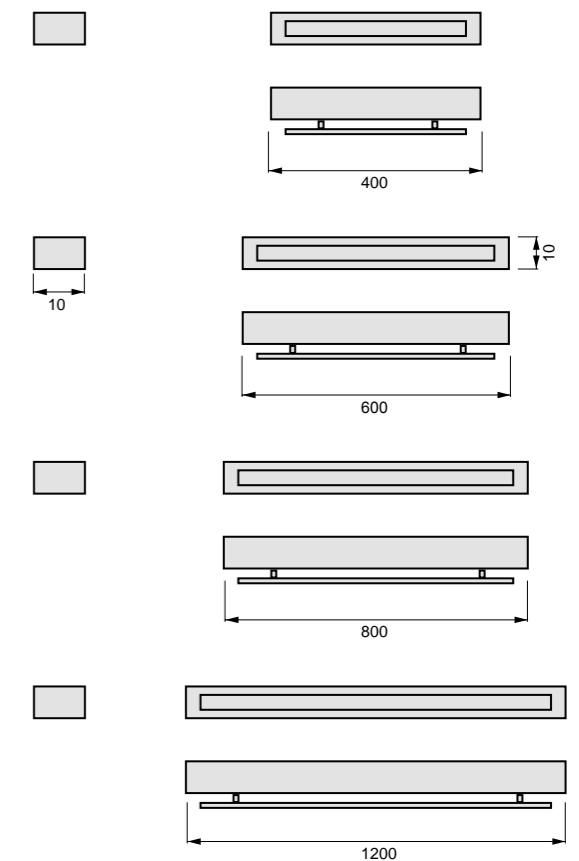

Flut



Lavabi Flut Washbasins Flut collection



Cod. FLLAVFSQU42
42x42xh15



Cod. FLLAVBW80
80x48xh15



Cod. FLLAVFSRO42
Ø42xh15



Cod. FLLAVBW65
65x48xh15

Lavabi Washbasins

In abbinamento alla collezione Flut, proponiamo 4 lavabi dalle diverse misure e caratteristiche tecnologiche..
For Flut collection we propose 4 different washbasins in sizes and technological characteristics.

cod. FLWC01

Vaso Flut Smart Clean scarico parete convertibile a pavimento mediante curva tecnica.
Wc Flut Smart Clean wall drain suitable for floor drain with technical elbow.

cod. FLWC01

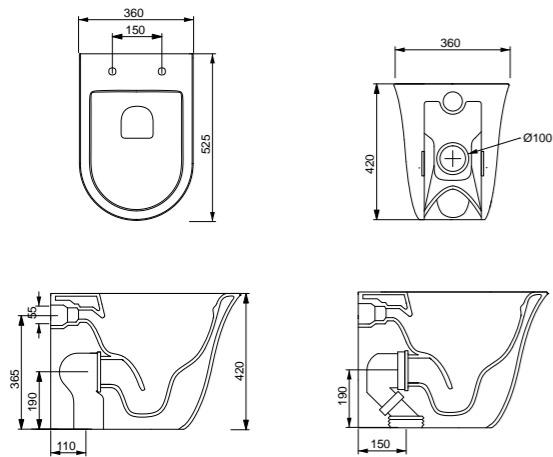

Con connessione eccentrica per scarico a suolo.

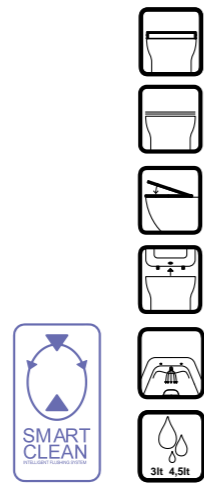

cod. FLBI01

Bidet Flut monoforo (senza foro e tre fori su richiesta)
Bidet Flut one hole (without hole and three holes on request)

cod. FLBI01

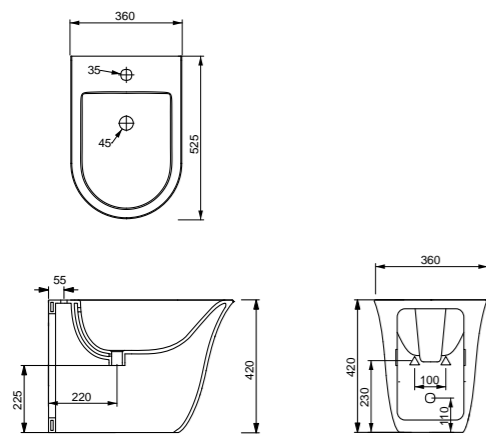

cod.
FLCOPRSLTICR



I Coprivater per i Wc Flut sono disponibili nelle versioni:
The Seatcovers Flut are available in the following models:

Avvolgente/*Wrapover* FLCOPRTICR
Slim FLCOPRSLTICR

LE MISURE INDICATE POSSONO VARIARE DEL 0.6% CIRCA, PER USURA STAMPI E PER VARIAZIONI DELLE CARATTERISTICHE TECNICHE DELLE MATERIE PRIME.

THE INDICATED SIZE COULD HAVE A VARIATION OF ABOUT 0.6% DUE TO THE USURE OF MOULDS AND VARIATIONS IN THE RAW MATERIALS.

cod. FLLAVFSRO42
 Lavabo Flut Tondo bordo fino, cm Ø42.
 Flut Washbasin Round cm Ø42 thin edge.

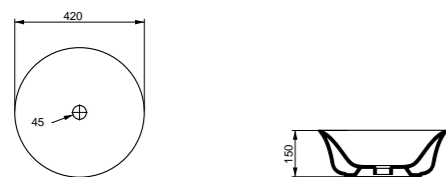

cod. FLLAVFSRO42

cod. FLLAVBW65
 Lavabo Flut cm 65 bordo fino, monoforo (senza foro, tre fori su richiesta).
 Flut Washbasin cm 65 thin edge one hole (no hole, three holes on request).

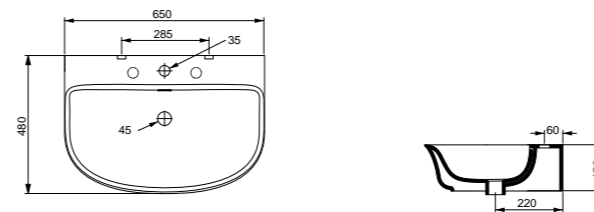

cod. FLLAVBW65

cod. FLLAVFSQU42
 Lavabo Flut Quadro bordo fino, cm 42.
 Flut Washbasin Square cm 42 thin edge.

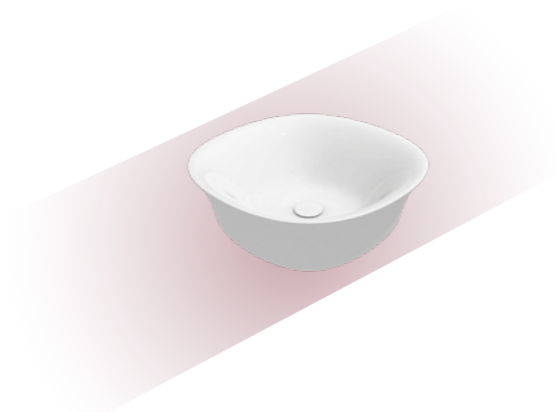
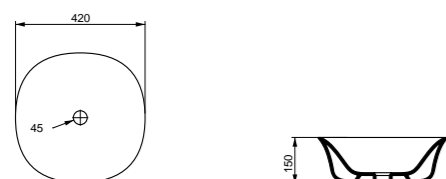

cod. FLLAVFSQU42

cod. FLLAVBW80
 Lavabo Flut cm 80 bordo fino, monoforo (senza foro, tre fori su richiesta).
 Flut Washbasin cm 80 thin edge one hole (no hole, three holes on request).

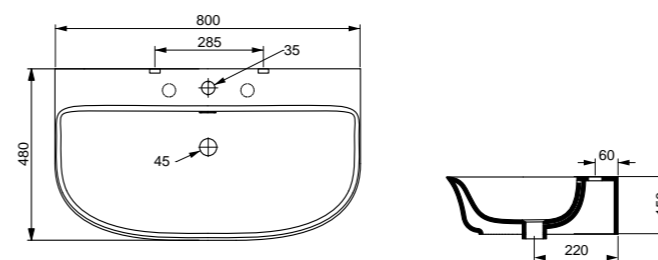

cod. FLLAVBW80

GSG

CERAMIC DESIGN

Controllo Qualità - *Quality passed*

Ogni prodotto GSG Ceramic Design è sottoposto ai test di alta qualità di GSG Ceramic Design per essere conforme alla normativa UNI.

Any GSG Ceramic Design product is tested to match the GSG high quality controls and to be conform to UNI standards

Garanzia - *Warranty*

In osservanza della Direttiva Europea 1999/44/CE, recepita in Italia con D. lgs n. 206 del Codice di Consumo, GSG Ceramic Design riconoscerà eventuali difetti di conformità dei propri prodotti che si dovessero manifestare entro il termine di 24 mesi dalla loro vendita al cliente finale. L'unica spettanza di GSG Ceramic Design per tali pezzi è la loro sostituzione.

In observance of European Directive 1999/44/EC, implemented in Italy with Legislative Decree no. 206 of the Consumer's Code, GSG Ceramic Design will recognize any lack of conformity of their products that may be found within the period of 24 months from their sale to the end customer.

The only pertaining of GSG Ceramic Design for these pieces is their replacement.

Manutenzione - *Maintenance*

I sanitari GSG Ceramic Design con la loro smaltatura di altissima qualità possono essere puliti perfettamente con semplice acqua tiepida e sapone o detersivo non abrasivo. L'uso di detersivi abrasivi per la pulizia danneggia la smaltatura.

GSG Ceramic Design sanitary ware due to its high quality glazing can be perfectly cleaned with simple warm water and soap or non-abrasive detergent. The use of abrasives detergents for cleaning damage the glazing.

NOTES

Stampato su carta certificata proveniente da foreste gestite in modo sostenibile.

Printed on certified paper from sustainably managed forests.

Il marchio ed il logo GSG Ceramic Design sono marchi registrati.

GSG Ceramic Design diffida l'utilizzo dei propri marchi, loghi, nomi di dominio e ragione sociale anche dove non registrati.

I diritti di riproduzione di fotografie o testi contenuti in questo catalogo appartengono esclusivamente a GSG Ceramic Design.

Qualsiasi uso o riproduzione di fotografie o testi contenuti in questo catalogo senza il previo consenso di GSG Ceramic Design è espressamente vietata e soggetta alla normativa sul copyright intellettuale.

The brand and the GSG Ceramic Design logo are registered trademarks.

GSG Ceramic Design distrusts the use of its trademarks, logos, and company domain names even where not registered.

reproduction rights of photos or texts contained in this catalog belong exclusively to GSG Ceramic Design.

Any use or reproduction of photos or texts contained in this catalog without prior written approval of GSG Ceramic Design is expressly prohibited and subject to the laws on intellectual copyright.

GSG Ceramic Design si riserva il diritto di apportare upgrade tecnici ai propri prodotti senza alcun preavviso.

GSG Ceramic Design reserves the right to make technical upgrades to its products without prior notice.

MADE IN EU

GSG Ceramic Design s.r.l. Via Brunelleschi, 27

01033 Civita Castellana (VT) Italia

Tel. + 39 0761/515258 Fax + 39 0761/517444

www.ceramicagsg.it e-mail: info@ceramicagsg.it

Le nostre certificazioni:
Our certifications:

ISO9001 : 2008





GSG Ceramic Design srl
Via Brunelleschi 27 - 01033 - Civita Castellana (VT) - Italy
Tel +39 0761 515258 - 516194 - Fax +39 0761 517444
www.ceramicagsg.it - info@ceramicagsg.it